

APPROVED: \_\_\_\_\_

DATE: \_\_\_\_\_ TITLE: \_\_\_\_\_

Rev	AWO #	Description	Date	Appr
-		RELEASED	11/7/22	
A		UPDATED TITLE	7/14/23	JJ/RC
B		ADDED SPEC.	7/25/23	LH/RC
C		UPDATE DIM.	11/22/23	LH/SL2

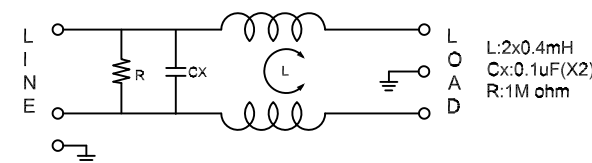
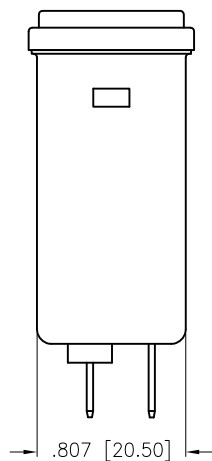
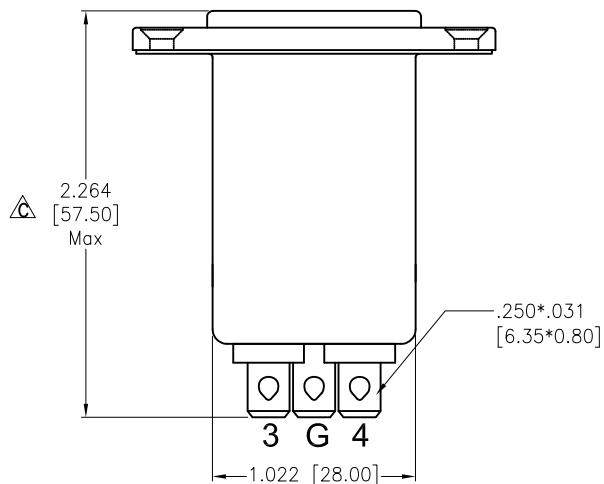
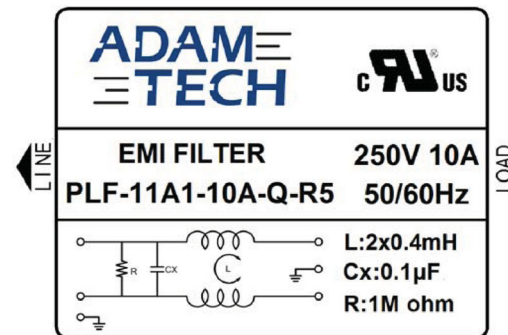
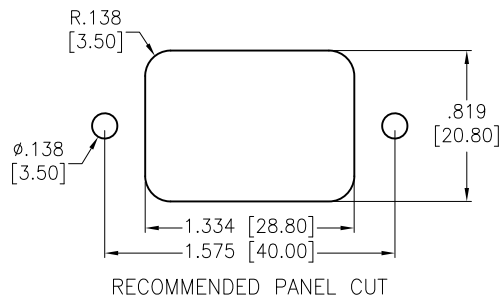
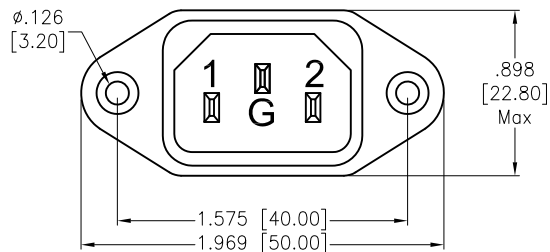

**SPECIFICATIONS:**

**Electrical:**

Voltage rating: 115/250 VAC  
 Current rating: 115/250 VAC: 10A RMS max  
 Leakage Current: Each Line To Ground  
     @115VAC/60HZ 2.0uA max  
     @250VAC/50HZ 5.0uA max

**Hipot Rating(For 1 Minute)**

- A. Line to Ground: 2,250 VDC
- B. Line to Line: 500 VDC

IR: 50 Mohm @500 VDC Any Input or Output to Ground

Temperature Rating:  
 -25°C to +85°C

Environmental:  
 Lead free, RoHS compliant  Medical Grade 

UNLESS OTHERWISE SPECIFIED ALL DIMENSIONS ARE INCHES [MM]. TOLERANCES: EXCEPT AS NOTED

INCHES		HOLES	
.X	± .10	ØX	±.10
.XX	± .020	ØXX	±.015
.XXX	± .015	ØXXX	±.010

**ADAM TECH** 909 Rahway Avenue,  
 Union, NJ 07083  
 Phone: 908-687-5000  
 Fax: 908-687-5710

DRAWN	WX	11/7/22
CHECKED	RC	11/7/22
APPROVED		
THIS DRAWING CONTAINS INFORMATION THAT IS PROPRIETARY AND SHOULD NOT BE USED WITHOUT PRIOR WRITTEN PERMISSION FROM ADAM TECH		

TITLE FILTERED POWR ENTRY MODULE, MEDICAL GRADE 115/250VAC 10A, INLET, FLANGE MOUNT		
SIZE X	PART NO. PLF-11A1-10A-Q-R5	REV. C
REF: S00205C	SCALE: NTS	SHEET 1 OF 2

6

5

4

3

2

1

APPROVED: \_\_\_\_\_

DATE: \_\_\_\_\_ TITLE: \_\_\_\_\_

Rev	AWO #	Description	Date	Appr
SEE SHT 1 OF 2 FOR REVISION				

### INSERTION LOSS(IN 50 ohm system according IEC/CISPR

————— (common mode)  
 - - - - - (differential mode)

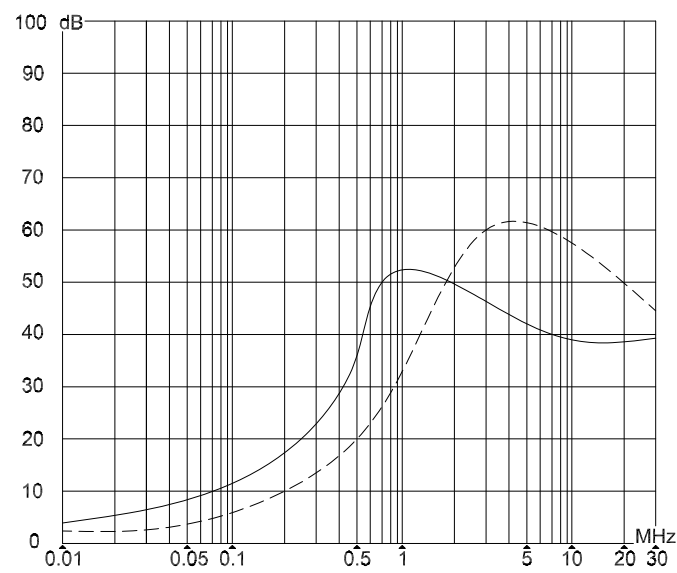

UNLESS OTHERWISE SPECIFIED ALL DIMENSIONS ARE INCHES [MM]. TOLERANCES: EXCEPT AS NOTED

INCHES		HOLES	
.X	± .10	ØX	±.10
.XX	± .020	ØXX	±.015
.XXX	± .015	ØXXX	±.010

**ADAM TECH** 909 Rahway Avenue,  
 Union, NJ 07083  
 Phone: 908-687-5000  
 Fax: 908-687-5710

DRAWN	WX	11/7/22
CHECKED	RC	11/7/22
APPROVED		

TITLE  
**FILTERED POWR ENTRY MODULE, MEDICAL GRADE  
 115/250VAC 10A, INLET, FLANGE MOUNT**

THIS DRAWING CONTAINS INFORMATION THAT IS PROPRIETARY AND SHOULD NOT BE USED WITHOUT PRIOR WRITTEN PERMISSION FROM ADAM TECH

SIZE <b>X</b>	PART NO. <b>PLF-11A1-10A-Q-R5</b>	REV. <b>C</b>
REF: S00205C	SCALE: NTS	SHEET 2 OF 2

6

5

4

3

2

1