

6

5

4

3

2

1

APPROVED: \_\_\_\_\_

DATE: \_\_\_\_\_ TITLE: \_\_\_\_\_

Rev	AWO #	Description	Date	Appr
-		RELEASED	6/8/22	
A		ADDED PACKING	6/16/22	JJ/JL

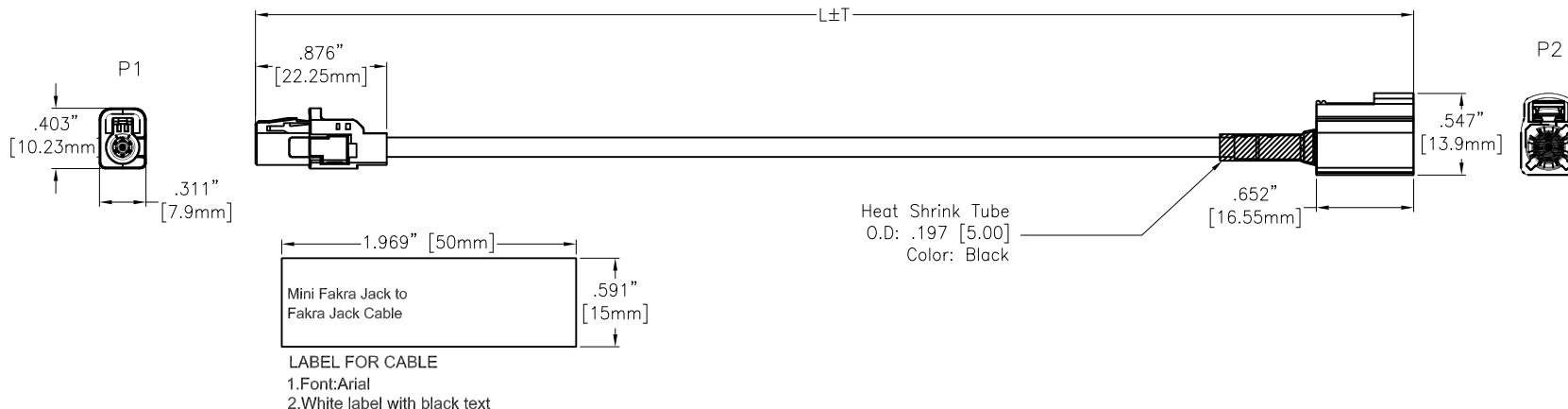

LABEL FOR CABLE  
 1.Font:Arial  
 2.White label with black text

ADAM P/N	L+T
CA-AM01XJ-1FJX-1M	39.370"±1.181" [1000±30mm]
CA-AM01XJ-1FJX-1.9M	74.803"±1.181" [1900±30mm]
CA-AM01XJ-1FJX-2.5M	98.425"±1.969" [2500±50mm]

**SPECIFICATIONS:**

**Connector:**

P1= Mini FAKRA Code see Page 2, Jack, Straight, Type A, 30u" Gold Plated, UL94-V0

P2= FAKRA Code see Page 3, Jack, Straight, 30u" Gold Plated, UL94-V0

**Cable:**

Cable Coaxial+AL+Braid, O.D: .130" [3.3mm], Jacket Color: Black

**Electrical:**

Impedance: 50 Ohm

Temperature Rating:

-40°C to +105°C

**Electrical Test:**

All Assemblies must be 100% Tested for Shorts, Open, Continuity, and Physical Appearance.

**Environmental:**

Lead free, RoHS compliant



UNLESS OTHERWISE SPECIFIED ALL DIMENSIONS ARE INCHES [MM]. TOLERANCES: EXCEPT AS NOTED

INCHES		HOLES	
.X	±.10	Ø.X	±.10
.XX	±.020	Ø.XX	±.015
.XXX	±.015	Ø.XXX	±.010



909 Rahway Avenue,  
Union, NJ 07083  
Phone: 908-687-5000  
Fax: 908-687-5710

DRAWN	WX	6/8/22
CHECKED	JL	6/8/22
APPROVED		

TITLE  
MINI FAKRA JACK A TYPE STRAIGHT  
TO FAKRA JACK STRAIGHT, OD 3.3 CABLE

THIS DRAWING CONTAINS INFORMATION THAT IS PROPRIETARY AND SHOULD NOT BE USED WITHOUT PRIOR WRITTEN PERMISSION FROM ADAM TECH

SIZE X	PART NO. CA-AM01XJ-1FJX-XM	REV. A
REF: S00013T	SCALE: NTS	SHEET 1 OF 4

6

5

4

3

2

1

6

5

4

3

2

1

APPROVED: \_\_\_\_\_

DATE: \_\_\_\_\_ TITLE: \_\_\_\_\_

Rev	AWO #	Description	Date	Appr
-----	-------	-------------	------	------

SEE SHT 1 OF 4 FOR REVISION

Mini Fakra A CA-AM01XJ-1FJX-XM

CODING A	CODING B	CODING C	CODING D	CODING E	CODING F	CODING G	CODING H
Black	White	Blue	Claret Violet	Green	Brown	Grey	Light Pink
CODING J	CODING K	CODING Z	All Coding				
Belge	Curry	Water Blue					

UNLESS OTHERWISE SPECIFIED ALL DIMENSIONS ARE INCHES [MM]. TOLERANCES: EXCEPT AS NOTED

INCHES		HOLES	
.X ±.10	∅.X ±.10	.XX ±.020	∅.XX ±.015
.XXX ±.015	∅.XXX ±.010		

**ADAM TECH**

909 Rahway Avenue,  
Union, NJ 07083  
Phone: 908-687-5000  
Fax: 908-687-5710

DRAWN	WX	6/8/22
CHECKED	JL	6/8/22
APPROVED		

TITLE  
MINI FAKRA JACK A TYPE STRAIGHT  
TO FAKRA JACK STRAIGHT, OD 3.3 CABLE

THIS DRAWING CONTAINS INFORMATION THAT IS PROPRIETARY AND SHOULD NOT BE USED WITHOUT PRIOR WRITTEN PERMISSION FROM ADAM TECH

SIZE X	PART NO. CA-AM01XJ-1FJX-XM	REV. A
REF: S00013T	SCALE: NTS	SHEET 2 OF 4

6

5

4

3

2

1

6

5

4

3

2

1

APPROVED: \_\_\_\_\_

DATE: \_\_\_\_\_ TITLE: \_\_\_\_\_

Rev	AWO #	Description	Date	Appr
-----	-------	-------------	------	------

SEE SHT 1 OF 4 FOR REVISION

Fakra CA-AM01XJ-1FJX-XM

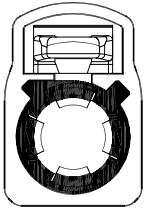
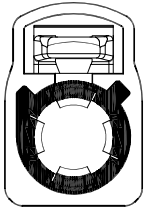
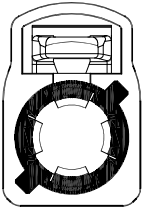
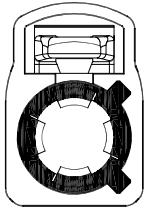
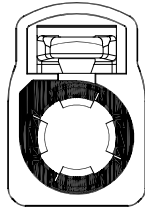
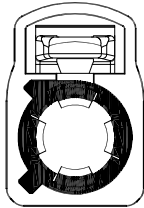
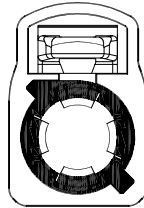
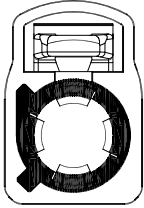
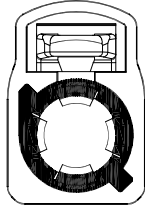
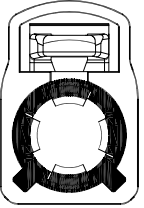
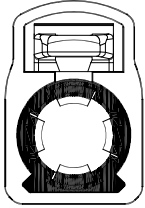
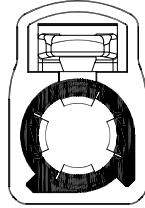
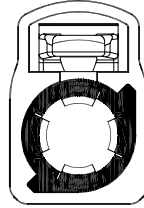
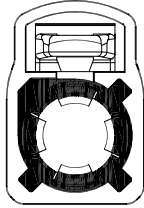
Coding	A	B	C	D	E	F	G
Plug							
Color	Black	White	Blue	Bordeaux Violet	Green	Brown	Grey
Coding	H	I	K	L	M	N	Z
Plug							
Color	Violet	Beige	Curry	Carmine Red	Pastel Orange	Pastel Green	Water Blue

UNLESS OTHERWISE SPECIFIED ALL DIMENSIONS ARE INCHES [MM]. TOLERANCES: EXCEPT AS NOTED

INCHES		HOLES	
.X	± .10	∅.X	± .10
.XX	± .020	∅.XX	± .015
.XXX	± .015	∅.XXX	± .010

**ADAM TECH**

909 Rahway Avenue,  
Union, NJ 07083  
Phone: 908-687-5000  
Fax: 908-687-5710

DRAWN	WX	6/8/22
CHECKED	JL	6/8/22
APPROVED		

TITLE  
MINI FAKRA JACK A TYPE STRAIGHT  
TO FAKRA JACK STRAIGHT, OD 3.3 CABLE

THIS DRAWING CONTAINS INFORMATION THAT IS PROPRIETARY AND SHOULD NOT BE USED WITHOUT PRIOR WRITTEN PERMISSION FROM ADAM TECH

SIZE X	PART NO. CA-AM01XJ-1FJX-XM	REV. A
-----------	-------------------------------	-----------

REF: S00013T	SCALE: NTS	SHEET 3 OF 4
--------------	------------	--------------

6

5

4

3

2

1

6

5

4

3

2

1

APPROVED: \_\_\_\_\_

DATE: \_\_\_\_\_ TITLE: \_\_\_\_\_

Rev	AWO #	Description	Date	Appr
-----	-------	-------------	------	------

SEE SHT 1 OF 4 FOR REVISION

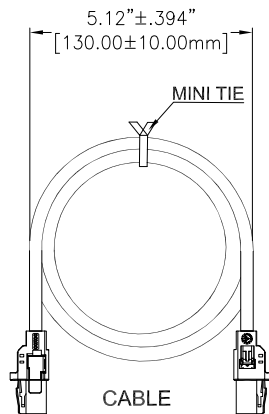

+

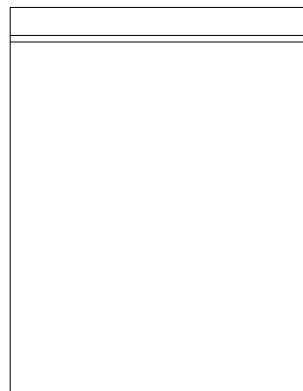

240(L)\*170(W) ZIP BAG

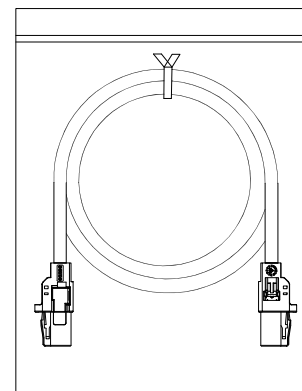

1PC/ZIP BAG

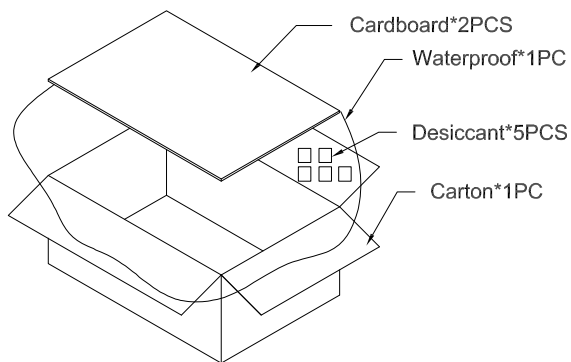

16"(L)\*13"(W)\*6.5"(H)

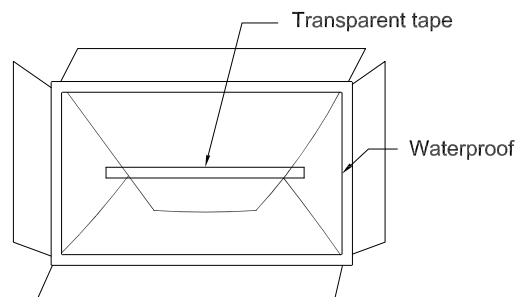

(After the installed Product, carton sealing tape should be transparent)

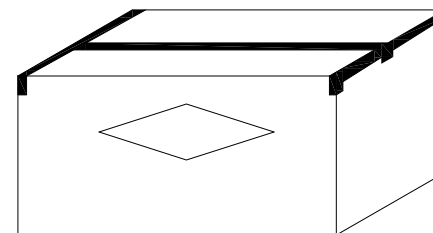

UNLESS OTHERWISE SPECIFIED ALL DIMENSIONS ARE INCHES [MM]. TOLERANCES: EXCEPT AS NOTED

INCHES		HOLES	
.X	± .10	Ø.X	± .10
.XX	± .020	Ø.XX	± .015
.XXX	± .015	Ø.XXX	± .010

**ADAM TECH**

909 Rahway Avenue,  
Union, NJ 07083  
Phone: 908-687-5000  
Fax: 908-687-5710

DRAWN	WX	6/8/22
CHECKED	JL	6/8/22
APPROVED		

TITLE  
MINI FAKRA JACK A TYPE STRAIGHT  
TO FAKRA JACK STRAIGHT , OD 3.3 CABLE

THIS DRAWING CONTAINS INFORMATION THAT IS PROPRIETARY AND SHOULD NOT BE USED WITHOUT PRIOR WRITTEN PERMISSION FROM ADAM TECH

SIZE X	PART NO. CA-AM01XJ-1FJX-XM	REV. A
-----------	-------------------------------	-----------

REF: S00013T SCALE: NTS SHEET 4 OF 4

6

5

4

3

2

1