

APPROVED: _____

DATE: _____ TITLE: _____

Rev	AWO #	Description	Date	Appr
-		RELEASED	10/28/22	
A		UPDATED SPEC.	12/14/22	JJ/RC
B		UPDATED SPEC.	6/16/23	WX/YC
C		UPDATED DRAWING	9/26/23	WX/YC
D		UPDATED SPEC.	4/18/25	LW1/KC
E		UPDATED SPEC.	5/21/25	WY/AC

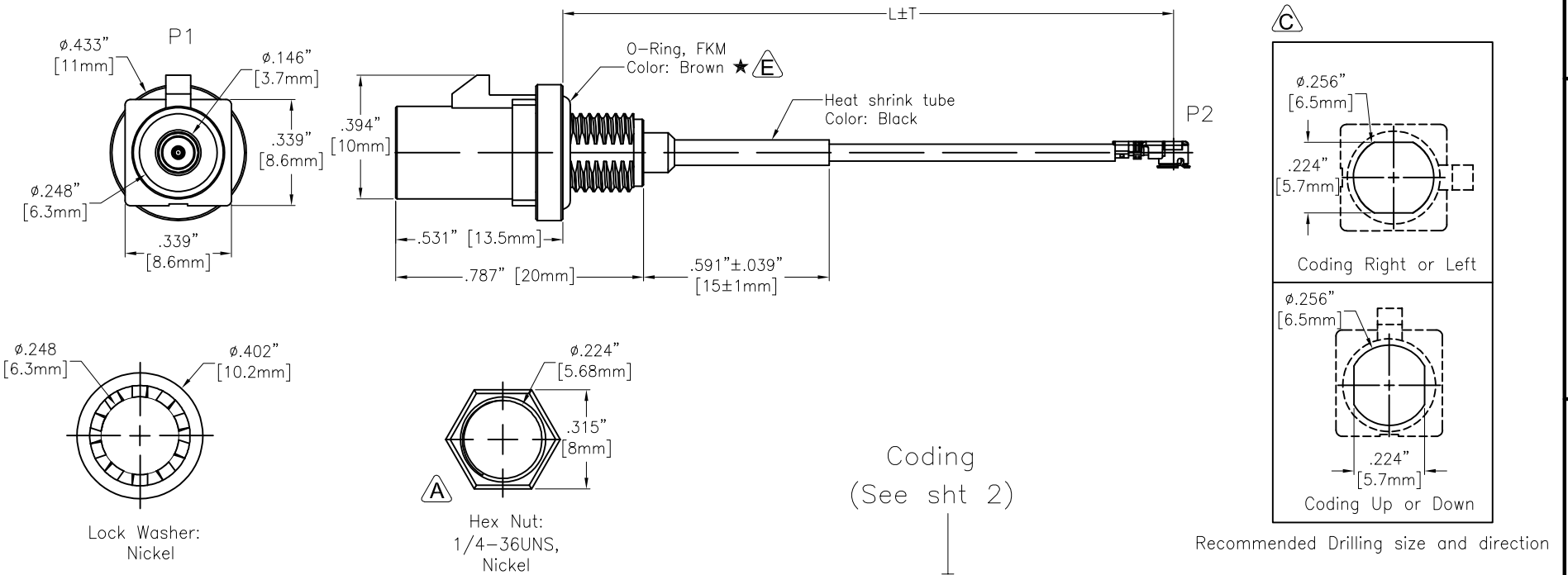

CA-FMP4-XX001XWP

ADAM P/N	L+T	
CA-FMP4-XX001005WP	1.969"±.197"	50±5mm
CA-FMP4-XX001010WP	3.937"±.197"	100±5mm
CA-FMP4-XX001015WP	5.906"±.197"	150±5mm
CA-FMP4-XX001020WP	7.874"±.197"	200±5mm
CA-FMP4-XX001030WP	11.811"±.197"	300±5mm

SPECIFICATIONS:

Connector:

P1= FAKRA Plug Code See page2, Straight, Terminal: Brass Gold Plated, Shell: Brass, Nickel
 P2= I-PEX MHF 4L 20632, Gold plated

Cable:

30AWG, OD: .054" [1.37mm], Jacket Color: Grey

Electrical:

Impedance: 50ohm

Temperature Rating:

Operating temperature: -40°C to +90°C

Electrical Test:

All Assemblies must be 100% Tested for Shorts, Open, Continuity, and Physical Appearance.

Environmental:

IP Rating: IP67 (Connector to panel)

Lead free, RoHS compliant



UNLESS OTHERWISE SPECIFIED ALL DIMENSIONS ARE INCHES [MM]. TOLERANCES: EXCEPT AS NOTED		
INCHES		HOLES
.X ± .10	Ø.X ± .10	
.XX ± .020	Ø.XX ± .015	
.XXX ± .015	Ø.XXX ± .010	
DRAWN	WX	10/28/22
CHECKED	RC	10/28/22
APPROVED		
THIS DRAWING CONTAINS INFORMATION THAT IS PROPRIETARY AND SHOULD NOT BE USED WITHOUT PRIOR WRITTEN PERMISSION FROM ADAM TECH		

ADAM TECH

909 Rahway Avenue,
 Union, NJ 07083
 Phone: 908-687-5000
 Fax: 908-687-5710

TITLE CUSTOM CABLE ASSEMBLY, FAKRA PLUG STRAIGHT TO MHF 4L 20362, 30AWG, O.D: 1.37, IP67 RATED		
SIZE X	PART NO. CA-FMP4-XX001XWP	REV. E
REF: S00013T	SCALE: NTS	SHEET 1 OF 2

6

5

4

3

2

1

APPROVED: _____

DATE: _____ TITLE: _____

Rev	AWO #	Description	Date	Appr
SEE SHT 1 OF 2 FOR REVISION				

Fakra Jack

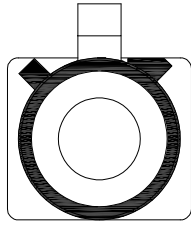
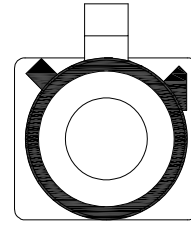
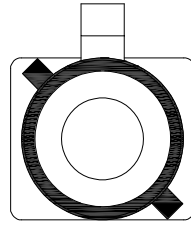
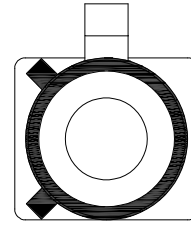
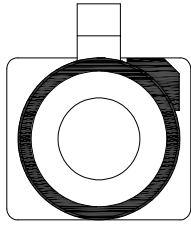
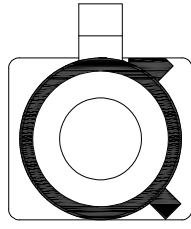
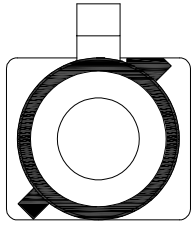
Coding	A	B	C	D	E	F	G
Plug							
Color	Back	White	Blue	Bordeaux Violet	Green	Brown	Grey

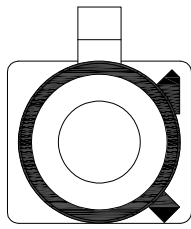
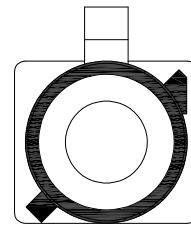
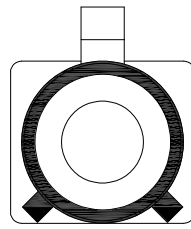
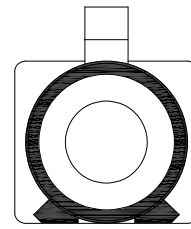
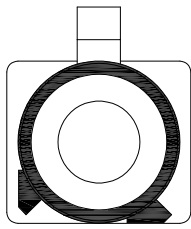
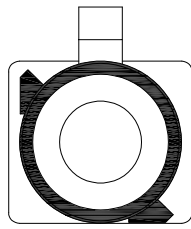
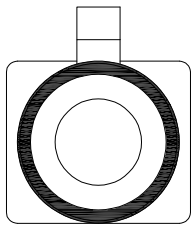
Coding	H	I	K	L	M	N	Z
Plug							
Color	Violet	Beige	Curry	Camine Red	Pastel Orange	Pastel Green	Water Blue

CA-FMP4-XX001XWP

P1 Coding

(Replace X with coding letter)

UNLESS OTHERWISE SPECIFIED ALL DIMENSIONS ARE INCHES [MM]. TOLERANCES: EXCEPT AS NOTED		
INCHES	HOLES	
.X ± .10	∅X	±.10
.XX ± .020	∅XX	±.015
.XXX ± .015	∅XXX	±.010
DRAWN	WX	10/28/22
CHECKED	RC	10/28/22
APPROVED		
THIS DRAWING CONTAINS INFORMATION THAT IS PROPRIETARY AND SHOULD NOT BE USED WITHOUT PRIOR WRITTEN PERMISSION FROM ADAM TECH		

ADAM TECH	909 Rahway Avenue, Union, NJ 07083 Phone: 908-687-5000 Fax: 908-687-5710	
	TITLE CUSTOM CABLE ASSEMBLY, FAKRA PLUG STRAIGHT TO MHF 4L 20362, , 30AWG, O.D: 1.37, IP67 RATED	
SIZE X	PART NO. CA-FMP4-XX001XWP	REV. E
REF: S00013T	SCALE: NTS	SHEET 2 OF 2

6

5

4

3

2

1