

APPROVED: _____
 DATE: _____ TITLE: _____

Rev	AWO #	Description	Date	Appr
-		RELEASED	9/23/21	
A		UPDATE SPEC.	4/15/22	WX/RC
B		ADDED DRAWING	5/27/22	WX/RC

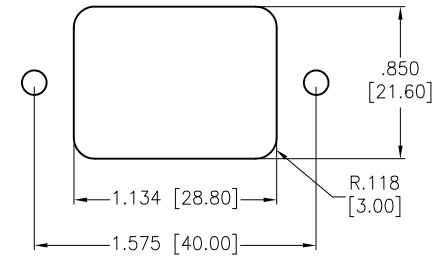

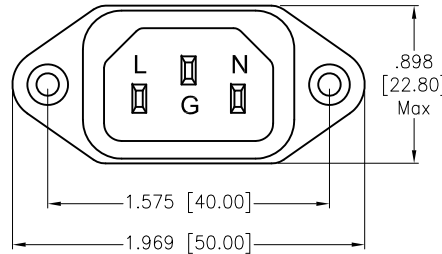
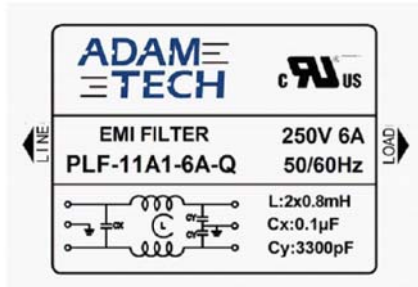
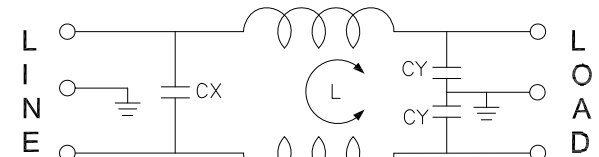
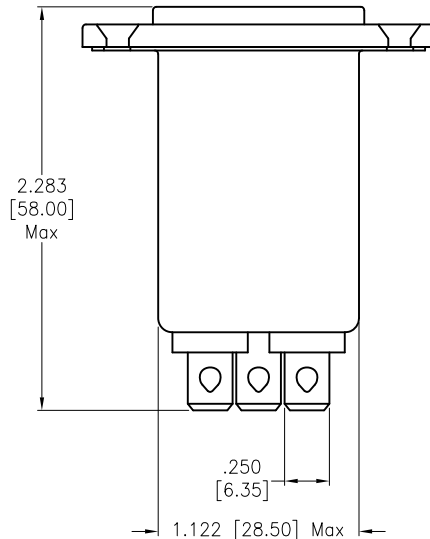
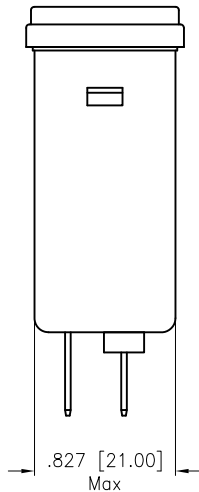

RECOMMENDED PANEL CUT



L: 2x0.8mH
 Cx: 0.1uF(X2)
 Cy: 3300pF(Y2)

SPECIFICATIONS:

Electrical:
 Voltage rating: 115/250 VAC
 Current rating: 115/250 VAC: 6A RMS max
 Leakage Current: Each Line To Ground
 @115VAC/60HZ 0.4mA max
 @250VAC/50HZ 0.8mA max
 Hipot Rating(For 1 Minute)
 A. Line to Ground: 2,250 VDC
 B. Line to Line: 1450 VDC 
 IR: 50 Mohm @500 VDC Any Input or Output to Ground
 Temperature Rating:
 -25°C to +85°C
 Environmental:
 Lead free, RoHS compliant 

UNLESS OTHERWISE SPECIFIED ALL DIMENSIONS ARE INCHES [MM]. TOLERANCES: EXCEPT AS NOTED

INCHES		HOLES	
.X	± .10	Ø.X	± .10
.XX	± .020	Ø.XX	± .015
.XXX	± .015	Ø.XXX	± .010

DRAWN	WX	9/23/21
CHECKED	RC	9/23/21
APPROVED		

THIS DRAWING CONTAINS INFORMATION THAT IS PROPRIETARY AND SHOULD NOT BE USED WITHOUT PRIOR WRITTEN PERMISSION FROM ADAM TECH

ADAM TECH

909 Rahway Avenue,
 Union, NJ 07083
 Phone: 908-687-5000
 Fax: 908-687-5710

TITLE
**EMI/RF POWER FILTER, INLET SOCKET,
 W/FLANGE MOUNTING**

SIZE	PART NO.	REV.
X	PLF-11A1-6A-Q	B

REF: S00205C SCALE: NTS SHEET 1 OF 2

6

5

4

3

2

1

APPROVED: _____

DATE: _____ TITLE: _____

Rev	AWO #	Description	Date	Appr
-----	-------	-------------	------	------

SEE SHT 1 OF 2 FOR REVISION

INSERTION LOSS(IN 50 ohm system according IEC/CISPR

_____ (common mode)
 - - - - - (differential mode)

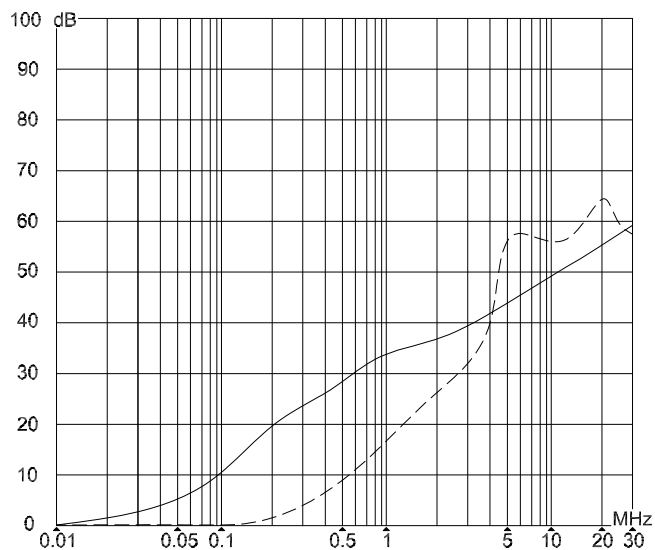

UNLESS OTHERWISE SPECIFIED ALL DIMENSIONS ARE INCHES [MM]. TOLERANCES: EXCEPT AS NOTED

INCHES		HOLES	
.x	± .10	∅x	± .10
.xx	± .020	∅xx	± .015
.xxx	± .015	∅xxx	± .010



909 Rahway Avenue,
Union, NJ 07083
Phone: 908-687-5000
Fax: 908-687-5710

DRAWN	WX	9/23/21
CHECKED	RC	9/23/21
APPROVED		

TITLE	EM/RF POWER FILTER, INLET SOCKET, W/FLANGE MOUNTING
-------	--

THIS DRAWING CONTAINS INFORMATION THAT IS PROPRIETARY AND SHOULD NOT BE USED WITHOUT PRIOR WRITTEN PERMISSION FROM ADAM TECH

SIZE	PART NO.	REV.
X	PLF-11A1-6A-Q	B

REF:	S00205C	SCALE:	NTS	SHEET	2 OF 2
------	---------	--------	-----	-------	--------

6

5

4

3

2

1